

spa
ficha técnica
datasheet

ref.5551507

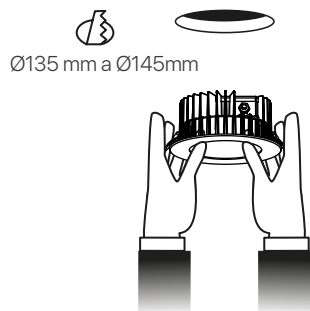
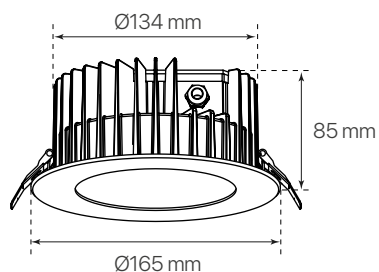
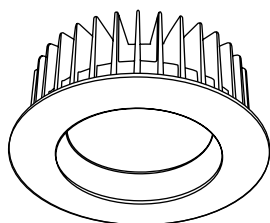

Nombre / Name	SPA
Referencia / Reference	5551507
Materiales / Materials	Aluminio+PMMA+Cristal / Aluminum + PMMA + Glass
Difusor / Diffuser	PMMA
Potencia / Power	20W
Temperatura de color / color temperature	4000K
Flujo luminoso / Lumens	2066lm
Dimable / Dimmable	No
Ángulo de apertura / Beam angle	90°
Ángulo de inclinación / Inclination angle	-
IP	IP65
IK	-
F.P. / P.F.	>0,9
UGR	-
IRC / CRI	>80
Chip	PHILIPS 2835
Driver	PHILIPS CERTA
Vida media (duración) / Average life	+30.000h
Clase energética / Energy class	A+
Aislamiento eléctrico / Electrical isolation	Clase II
Colores / Colors	Blanco / White
Medida exterior / Product size	Ø165mm x 85mm
Medida decorte / Cutting size	Ø140mm
Protección contra Sobretensiones / Surge protection	2kV
Tª (ambiente/trabajo) / Tª (environment/work)	-20°C ~ +45°C
Input	AC220 ~ 240V
Output	DC30-42V
Frecuencia / Frequency	50/60Hz
Peso / Weight	1,03kg
Certificados / Certificates	CE, RoHS
Garantía / Warranty	2 años/ 2 years